

2023

## Experimental procedure for Lab 08: Oscilloscopes Pandemic Edition

RLC, HP filter and LP filter, resonance, bandwidth, quality.  
Important note: when I say click, I mean single click only!

click on jsiggen icon



This screen will open

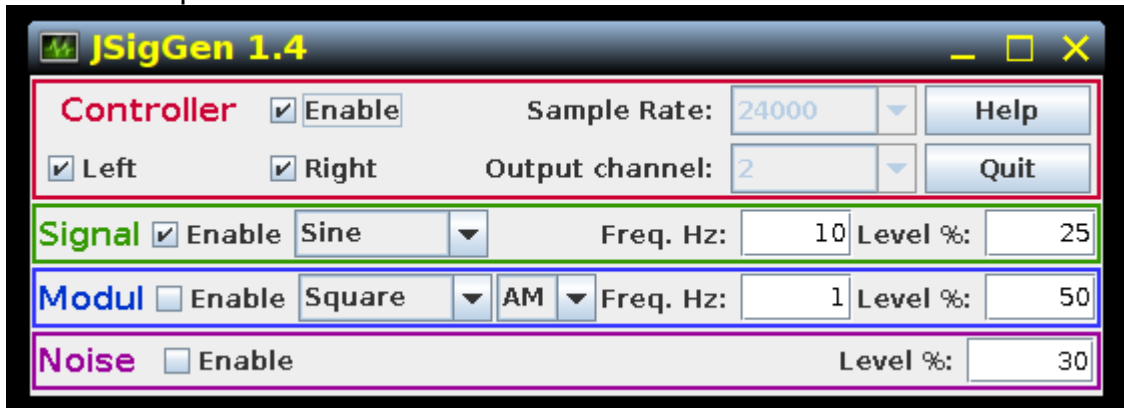

Click on the title bar to make this window active. You will be changing Freq. Hz:  
Note that you will not need to press enter for the frequency to change.

Click on the FreqAnalysis program icon.

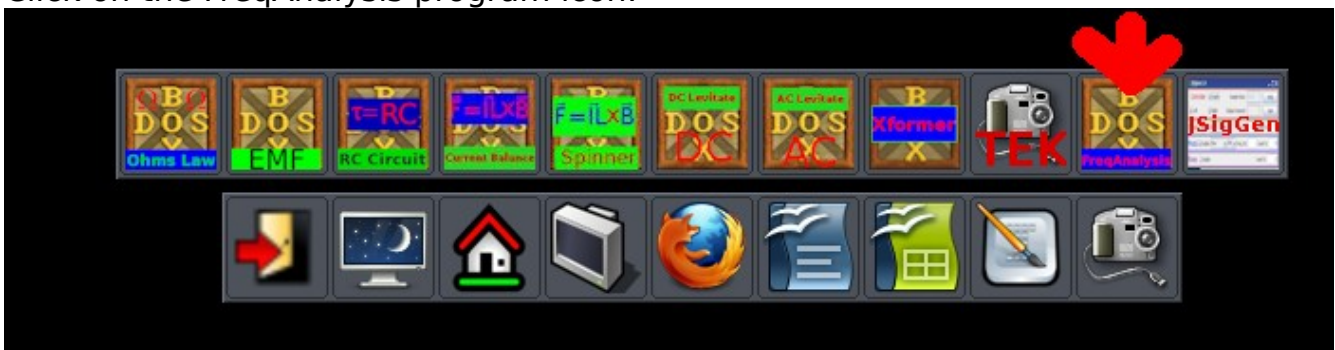

Arrange your screen to look something like what I have indicated below.

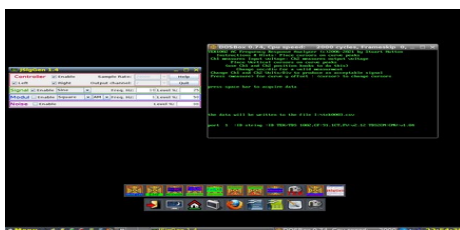

**Now I have an important note so read this!** To change frequency, you first need to click on the title bar for jsiggen. To make a measurement with the frequency analysis program, you need to click on the frequency analysis title bar. You will recognize which window is active because the text title will be bright yellow.

## Circuit connections

Your first circuit is the HP circuit. The circuit diagram is shown later. I should already have it connected for you.

The probes from your oscilloscope have a red band on channel one and a blue band on channel 2.

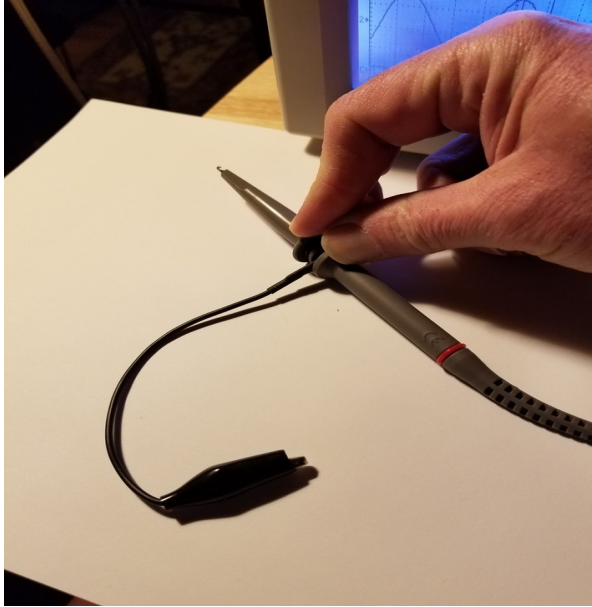

In this image to the left, the red band is visible. The black clip is the ground connection and the probe connector can be seen by pulling back on the probe head as I have indicated in the image. Also, less visible but on the side of these probes is a switch for 1x and 10x. This is a reference to the internal calibrated resistance of the probe. Your probe should be set to 1x only.

Your circuit will already have the probes properly connected when you come in for RLC measurements.

Now I want you to get a bit of practice with your oscilloscope to see what the various controls do. The image below is a typical connection. As I have it arranged, ch1 is on top and ch2 is on bottom on the scope. Ch1 will always read across the input. However the last element in the circuit must be connected to ch2 because the other side connects to ground. This is why each circuit must be connected differently.

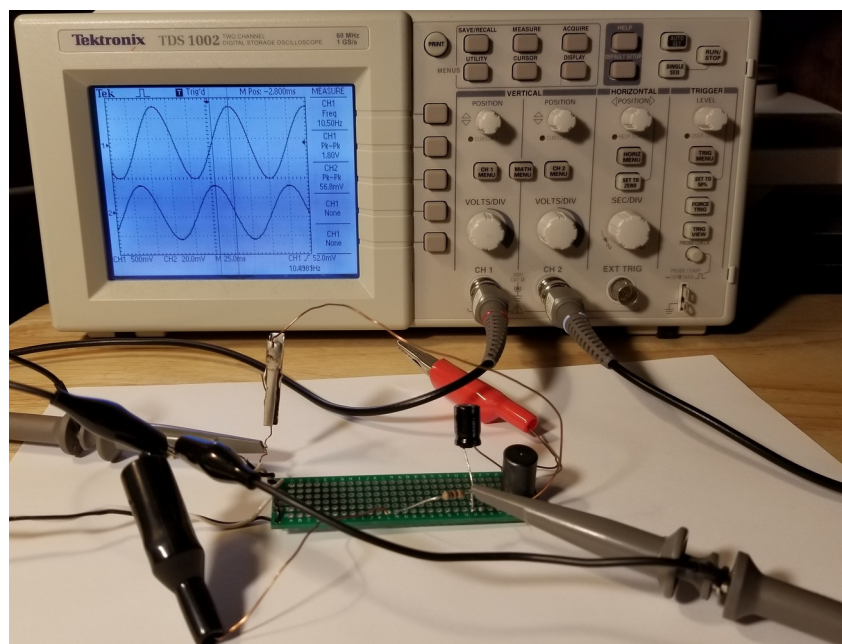

In the image below, I am numbering the buttons and knobs on your scope that you will be using. Use this as a guide and I will refer to the thing that needs doing by number only.



You should initially see Image 9 as the wave form. Turn 8 to the right 1 click and look at what it does. Turn it left two clicks. This acts like a zoom along the x axis. Turn it right 1 click and the screen should be back to it's original orientation.

Turn 4 right 1 click. Turn it then back 2 clicks. then turn it right 1 click, observing that this is the zoom for ch 1 y axis. Do the same with 6 and observe it is the zoom for ch 2 y axis.

Push 1 and you will see the original screen in Image 9. Push now 2. you will then see the screen appear differently (on the right hand side). What you have done is to toggle the operation of knobs 3 and 5. Push again 1 so we are back to Image 9.

For today, hopefully you will not need to use knobs 7 and 9 so I won't go over them except to say 9 controls the trigger level, and 7 shifts the x position of both curves.

I want you to see the dual operation of 3 and 5. Press 1, and turn 3 slightly. It moves ch1 up and down. Set 3 back close to where it was. Turn 5 in the same way. It moves ch2 up and down. Set 5 back close to where it was.

Now is an important step. Make sure you do this and understand this next step. Press 2.

Turn 2 until the vertical line that moves when you turn 3 is aligned on a peak on ch1. Turn 5 until the vertical line that moves when you turn 5 is aligned on the nearest peak on ch2. Here is a screen dump of my settings. I have placed notes over the two lines I am writing about.

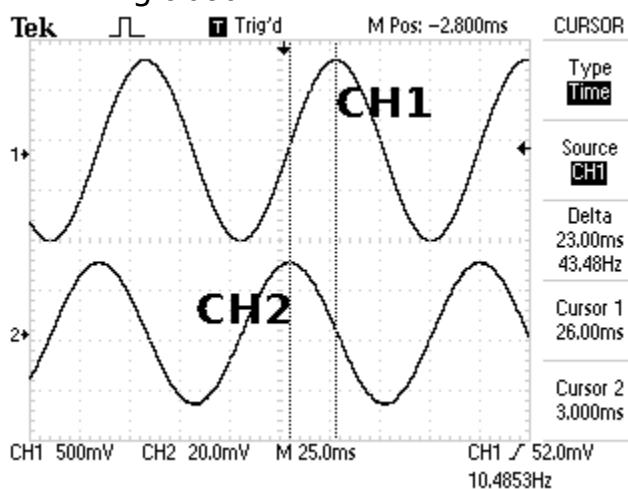

The image above shows the correct cursor settings that will allow a measurement of the time between those two peaks. By knowing the frequency (which the scope will measure) you can then determine the phase. Note that at resonance, the two peaks will have zero phase and at high frequencies, Ch2 will shift towards a positive phase shift. Below is a screen dump at 1000 Hz.

Note that I had to adjust knobs 4,6 and 8. I also had to push 1 and then move Ch1 and Ch2 down a bit with knobs 3 and 5. Then I had to press 2 and with knobs 3 and 5 set the cursors in the correct positions.

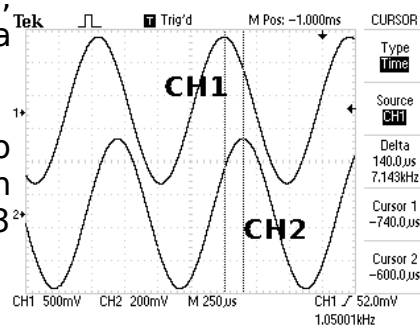

Now we are going to set the scope and make a measurement. This is going to be an example only. You will work your way down (or later up) step by step so there are no huge changes on the scope from previous measurements.

The siggen should have a frequency of 10000Hz. Your freq analysis program should be running on the computers as shown above. **Make sure to click the title bar for the freq analysis program.** The program says press space bar to acquire data. Press it one time. You will see the following appear at this point (I am showing a screen capture of my program. Note: if you pressed the space bar and nothing happened, it is probably because you did not click the title bar. Here is a screen capture of my program while it is running. Note that I am using a fairly old computer so my frequency from the sound card is not exactly that close to 10 Hz. It is going to be ok, though and the measured frequency will recorded in the data file. You will note also that the file name is automatically assigned here. Make sure that your version says (c) 2006-2021 since I have given this an important update.

```
DOSBox 0.74, Cpu speed: 2000 cycles, Frameskip 0, _
TEK1002 AC Frequency Response Analyzer (c)2006-2021 by Stuart Hutton
Instructions & Hints: Place cursors on curve peaks
Ch1 measures Input voltage: Ch2 measures output voltage
Place Vertical cursors on curve peaks
{use Ch1 and Ch2 position knobs to do this}
Change sec/div for a valid measurement
Change Ch1 and Ch2 Volts/Div to produce an acceptable signal
Press <measure> for curve y offset : <cursor> to change cursors

press: <t> to terminate <space bar> to record data
Measurement:Immed:Units?=>:MEASUREMENT:IMMED:UNITS "U"

Ch1:Freq[Hz]          Ch1:V Pk2Pk[V]      Ch2:V Pk2Pk[V]      Cursors: dT[s]
+1.05042E+01          +1.80000E+00        +5.60000E-02        -2.30000E-02

the data will be written to the file I:\tek0006.csv

Memory: 48092
port 1 :ID string :ID TEK/TDS 1002,CF:91.1CT,FU:v2.12 TDS2CM:CMU:v1.04
```

Reading across, these are the measurements: frequency , ch1 V peak to peak, ch2 V peak to peak and then the last column is the  $\Delta t$  from your cursors. The spreadsheet helper which I have confirmed works about the same for libreoffice as openoffice will convert your  $\Delta t$  measurement to a phase. Your first measurement here should have a negative dT in the last column. If not, make sure CH1 and CH2 cursors are on the correct peaks. Note the frequency shown above is not 10000 Hz. This is from an older version of the lab instructions.

Now I need to show you how to get the optimal measurement for dT. Turn knob 8 1 click to the right. Look at the program. It should say invalid measurement in red type. If not, turn knob 8 until it does say this, but only 1 click at a time and very slowly. You need to let the program make measurements which may take a second

or so. When you see Invalid measurement, turn knob 8 one click to the left. Set your cursors properly to measure dT and then you may press the space bar.

Click on the jsiggen title bar

enter 10000 (or the desired value) for the frequency

Click on the Freq Analysis title bar

Change 8 (turn it click by click to the right slowly) until you see Invalid measurement and then turn it back 1 click until the invalid measurement is gone.

Change 4 and 6 to get the signals on the screen

You may have to press 1 to change the location of CH1 and/or CH2 on the screen.

If you do, then press 2 after to set the cursors.

Use 3 and 5 to set the cursors for the measurement.

When this is done, press the space bar on the computer.

The frequencies to measure today for all the sections are these: (3 log spaced points per decade)

10

21.53

46.45

100

215.3

454.5

1000

2153

4545

10000

We start with the **high pass circuit**. With the high pass circuit, you will start at 10000 Hz and decrease the frequency to 10 Hz. For example, the next frequency after 10000 is 4545. I may need to set the initial settings on your scope for this.

Obtain your HP filter data and then terminate by pressing t.

At this point, you should ask me to come by and change your circuit to the **low pass circuit**. With the low pass circuit, you will start at 10 Hz and increase the frequency to 10000 Hz.

Obtain your LP filter data and then terminate by pressing t.

At this point, you should ask me to come by and change your circuit to the **RLC circuit**. With the RLC circuit, you will start at 10000 Hz and decrease the frequency to 10 Hz.

Obtain your RLC circuit data and then terminate by pressing t.

## Data Analysis

I am hoping you will have time to do the data analysis in the lab before you leave. If not, I have run the helpers under both openoffice and libreoffice. Note that the final fit will be determined by the minimum SqrStdDevSD cell.

I have 3 helpers for you today: the RLC, the HP and the LP helper. Paste your 4 columns of data into the appropriate helper. You will fit the data by changing  $\tau_L$  (the dark purple bar),  $\tau_c$  (the light purple bar) and for the RLC circuit, you will also have to adjust the amplitude (the blue bar). There are two other controls which will let you see the theoretical plot (with a lot more data generated by your fit) and you will also see the phase angle. Note that it shifts from a negative phase to a positive phase. This is because of the relative sizes of  $X_c$  and  $X_L$  and how these shift with frequency. You will also note that at resonance, the phase is zero which means the capacitive reactance is equal to the inductive reactance. The role of the amplitude control (the blue bar) is a bit obscure but is involved (at least for my measurements) with a factor close to  $1/\sqrt{2}$ . You might read my note about RMS values at the end of this. A discussion of this leads us too far astray.

You will also fit the response curves for the low pass and the high pass filters.

## Theory

### RLC Series Circuit

The response function  $A_v$  is the ratio of Ch2 to Ch1. For the RLC circuit, this is given by:

$$A_v \equiv \frac{V_{out}}{V_{in}} = \frac{IR}{IZ} = \frac{R}{\sqrt{R^2 + \left(\omega L - \frac{1}{\omega C}\right)^2}} = \frac{1}{\sqrt{1 + \left(\omega \frac{L}{R} - \frac{1}{\omega RC}\right)^2}}$$
$$\Rightarrow A_v = \frac{1}{\sqrt{1 + \left(\omega \tau_L - \frac{1}{\omega \tau_c}\right)^2}}$$

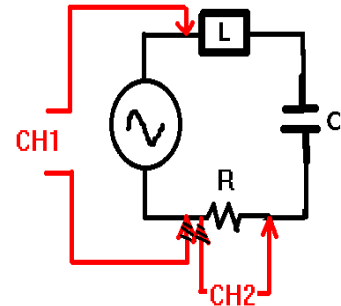

At resonance,

$$\text{resonance} \Rightarrow X_L = X_c \Rightarrow \omega_r L = \frac{1}{\omega_r C} \Rightarrow \omega_r = \sqrt{\frac{1}{LC}}$$

And the phase is given by:

$$\tan \phi = \frac{V_L - V_C}{V_R} = \frac{X_L - X_C}{R} = \frac{\omega L - \frac{1}{\omega C}}{R}$$

## HP Filter

The response function  $A_v$  is the ratio of Ch2 to Ch1. For the RLC circuit, this is given by:

$$A_v \equiv \frac{V_{out}}{V_{in}} = \frac{IR}{IZ} = \frac{\omega RC}{\sqrt{1+(\omega RC)^2}}$$

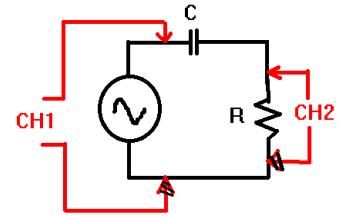

In the limits of low frequency  $A_v$  is zero and for high frequencies,  $A_v$  approaches 1.

The phase is given by:

$$\tan \delta = \frac{X_C}{R} = \frac{1}{\omega RC}$$

The phase measurements for these filter circuits are usually not particularly wonderful so no theoretical fit is provided here on the helper.

## LP Filter

The response function  $A_v$  is the ratio of Ch2 to Ch1. For the RLC circuit, this is given by:

$$A_v \equiv \frac{V_{out}}{V_{in}} = \frac{1}{\sqrt{1+(\omega RC)^2}}$$

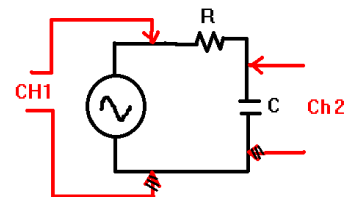

In the limits of low frequency  $A_v$  is 1 and for high frequencies,  $A_v$  approaches zero.

The phase is given by:

$$\tan \phi = -\frac{R}{X_C} = -\omega RC$$

The phase measurements for these filter circuits are usually not particularly wonderful so no theoretical fit is provided here on the helper.

Possible hypothesis for today's lab is impedance analysis provided for RLC, HP and LP circuits is consistent with expectations. My nominal values for the components are  $L=33\text{mH}$ ,  $C=4.7\mu\text{f}$  and  $R=100\ \Omega$  (for resistors you can get this from the color bands). This would give a resonance frequency of about 404 Hz which is when  $X_L=X_C$ .

### About RMS values:

Suppose a sinusoidally varying current is applied across a resistor  
(We're initially assuming the circuit is purely resistive):

$$I = I_m \sin(\omega t)$$

$$V = V_m \sin(\omega t)$$

The instantaneous power radiated is given by:

$$P = IV = I_m V_m \sin^2(\omega t)$$

It is not the instantaneous power which is so interesting: it is the time average power. This is given by:

$$\langle P \rangle = I_m V_m \langle \sin^2(\omega t) \rangle$$

From last semester, we know the time average of  $\sin^2(\omega t)$  has the value of  $\frac{1}{2}$ .

Thus:

$$\langle P \rangle = \frac{1}{2} I_m V_m$$

If we wrote, instead of the peak voltages and currents, these peaks scaled, we can make the form look the same as for DC. Thus, we define:

$$I_{\text{rms}} \equiv \frac{I_m}{\sqrt{2}}; V_{\text{rms}} \equiv \frac{V_m}{\sqrt{2}}$$

Then for a **purely resistive circuit**, we would have:

$$\langle P \rangle = I_{\text{rms}} V_{\text{rms}}$$

You need to know in a particular context if something is talking about peak values or rms values.

### RC - LC - RLC - RL series circuits

This analysis applies strictly to a series RLC circuit.

Impedance: We need to define some "resistive-like" quantities

(a) Inductive reactance:  $X_L \equiv \omega L$

(b) Capacitive reactance:  $X_C \equiv \frac{1}{\omega C}$

You can verify that these have units of Ohms.

Let's apply a sinusoidally varying current to the series circuit. At any time across the current is varying throughout the circuit as:

$$I = I_m \sin(\omega t)$$

Impedance for a **series** RLC circuit is then given by:

$$Z = \sqrt{R^2 + (X_L - X_C)^2}$$

An expression which is similar to what might be called Ohm's law for Impedance is:

$$V = IZ$$

The potential drop across the entire circuit will in general not be in phase with the applied current. In fact, it will vary as:

$$V = V_m \sin(\omega t + \delta)$$

For a purely capacitive circuit, the voltage across the capacitor lags behind the current by 90 degrees and the voltage drop across the capacitor is given by  $V_C = IX_C$ . For a RL circuit, the voltage across the inductor leads applied current by 90 degrees and the voltage drop across the inductor is given by  $V_L = IX_L$ . Across a purely resistive circuit, the voltage drop is in phase with the applied current and is given by  $V_R = IR$ .

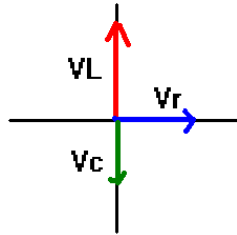

We can write this in terms of two vectors now using the difference between  $V_L$  and  $V_C$ .

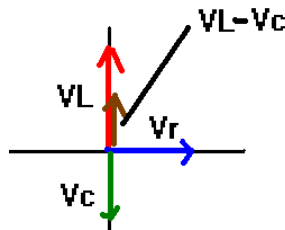

The magnitude of the instantaneous voltage is then given by :

$$|V| = \sqrt{V_R^2 + (V_L - V_C)^2} = I \sqrt{R^2 + (X_L - X_C)^2}$$

The angle between  $V_R$  and this instantaneous voltage is given by:

$$\tan \phi = \frac{V_L - V_C}{V_R} = \frac{X_L - X_C}{R} = \frac{\omega L - \frac{1}{\omega C}}{R}$$

The “power factor” is the cosine of this angle, and the average power radiated by the circuit is related to the power factor by:

$$\langle P \rangle = \langle IV \rangle = I_{\text{rms}} V_{\text{rms}} \cos \phi .$$

Here is another way to get the power factor:

Assuming the current is the same in all parts of the circuit, which is only the situation if we have a series circuit, then:

$$\text{PowerFactor} = \frac{\langle \text{True Power} \rangle}{\langle \text{Apparent Power} \rangle} = \frac{I_{\text{rms}}^2 R}{I_{\text{rms}}^2 Z} = \frac{R}{\sqrt{R^2 + (X_L - X_C)^2}} = \cos \phi$$

The resonance frequency will be given by

$$X_L = X_C \Rightarrow \omega L = \frac{1}{\omega C} \Rightarrow \omega_0 = \frac{1}{\sqrt{LC}}$$

which occurs when the power factor is 1 or impedance is minimized. The peak of the resonance curve is also going to be determined by the  $\langle \text{power} \rangle$  transmitted. Formally the peak is when maximum  $\langle \text{power} \rangle$  transmission happens and is given

by  $\frac{V_{\text{RMS}}^2}{R}$  , but **ONLY** at resonance. Otherwise the  $\langle \text{power} \rangle$  is given by

$\langle P \rangle = I_{\text{RMS}} V_{\text{RMS}} \cos(\phi)$  . The width ( $\Delta\omega$ ) is determined by the  $\langle \text{power} \rangle$

transmitted at  $\frac{V_{\text{RMS}}^2}{2R}$  (two values of  $\omega_1$  and  $\omega_2$  with  $\Delta\omega = \omega_2 - \omega_1$  ) which you may

call bandwidth. The quality of the circuit is given by  $Q \equiv \frac{\omega_0}{\Delta\omega} = \frac{\omega_0 L}{R}$  .